

Top View

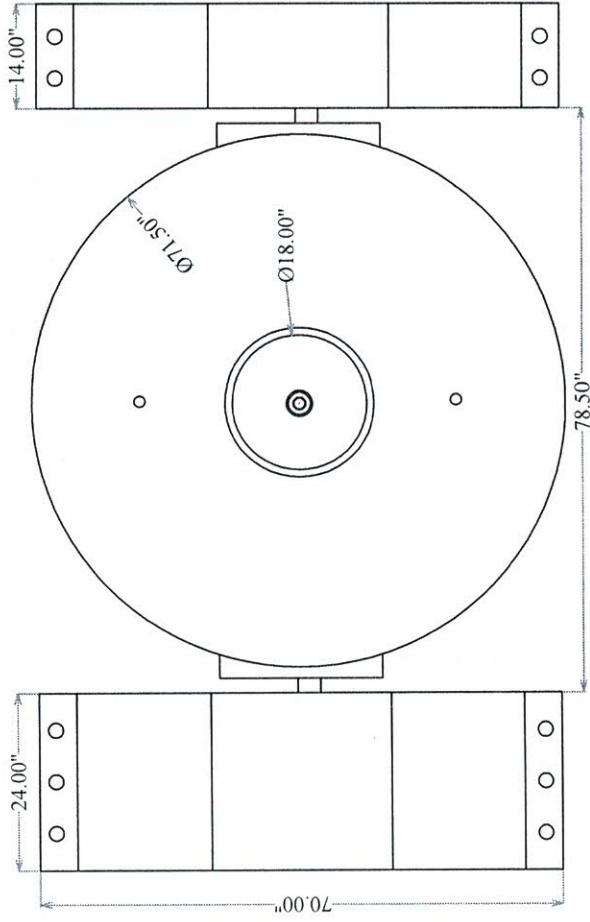

Front View

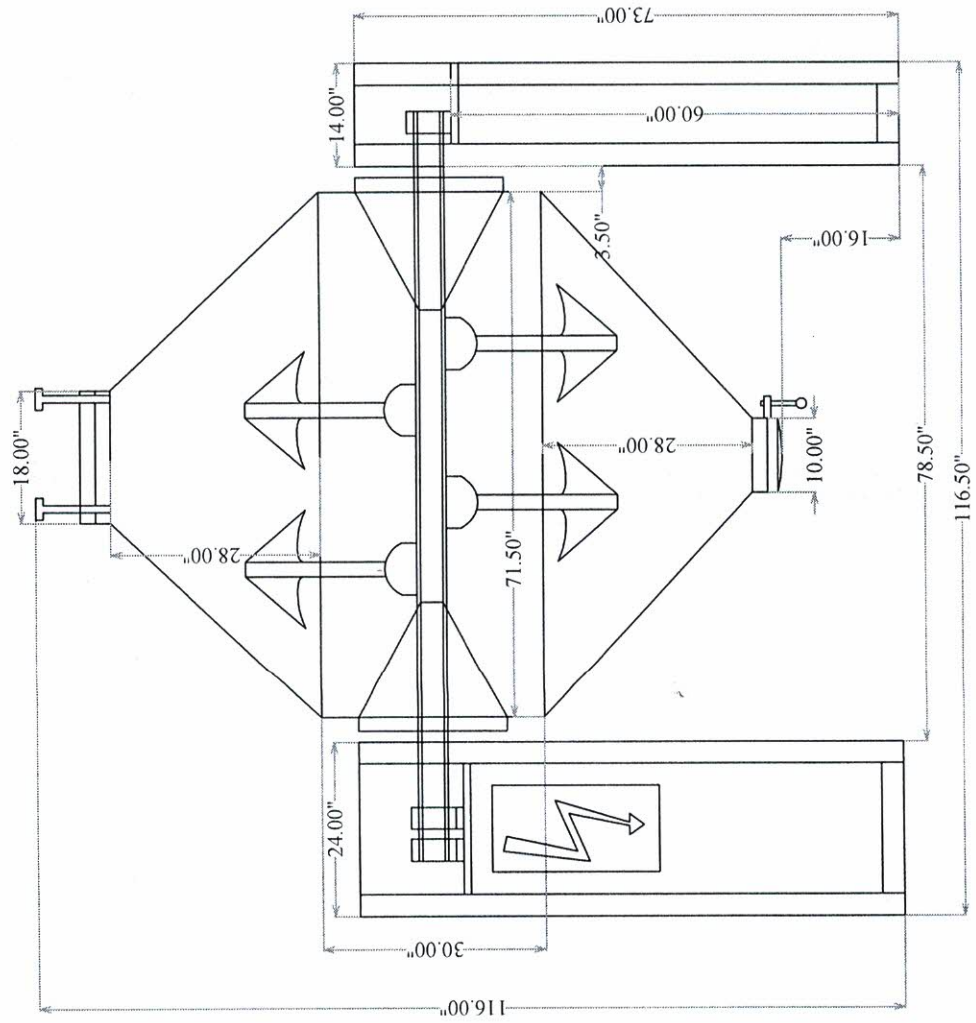

Company : Faisal Engineering
Prepared by : Younus Baig
Product : Cone Blender 1000 KG.
<b>Customer : Martin Dow Ltd</b>
All Sizes are in Inches

# Side View

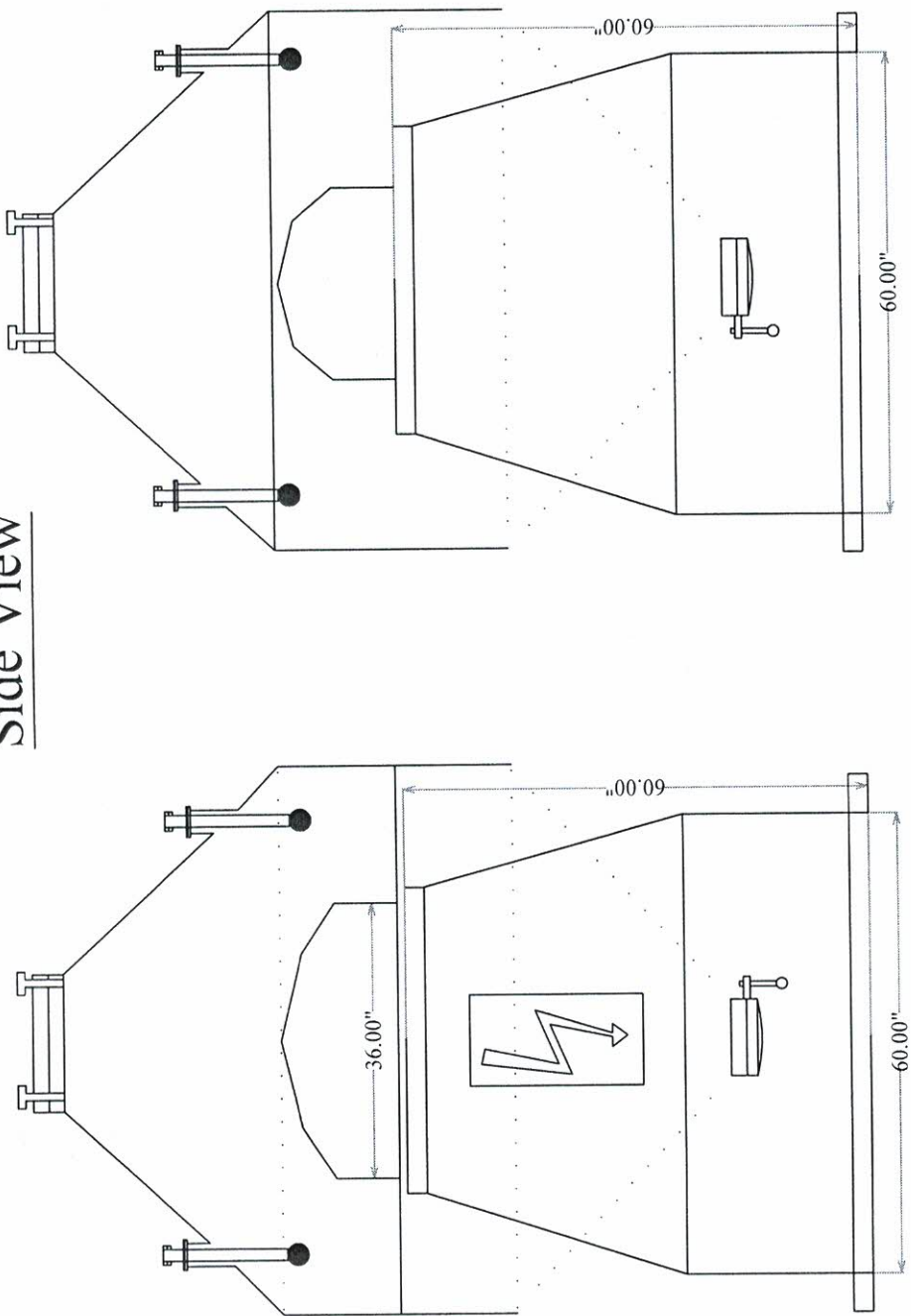

Company : Faisal Engineering
Prepared by : Younus Baig
Product : Cone Blender 1000 KG
<b>Customer : Martin Dow Ltd</b>
All Sizes are in Inches

# Mobile Platform

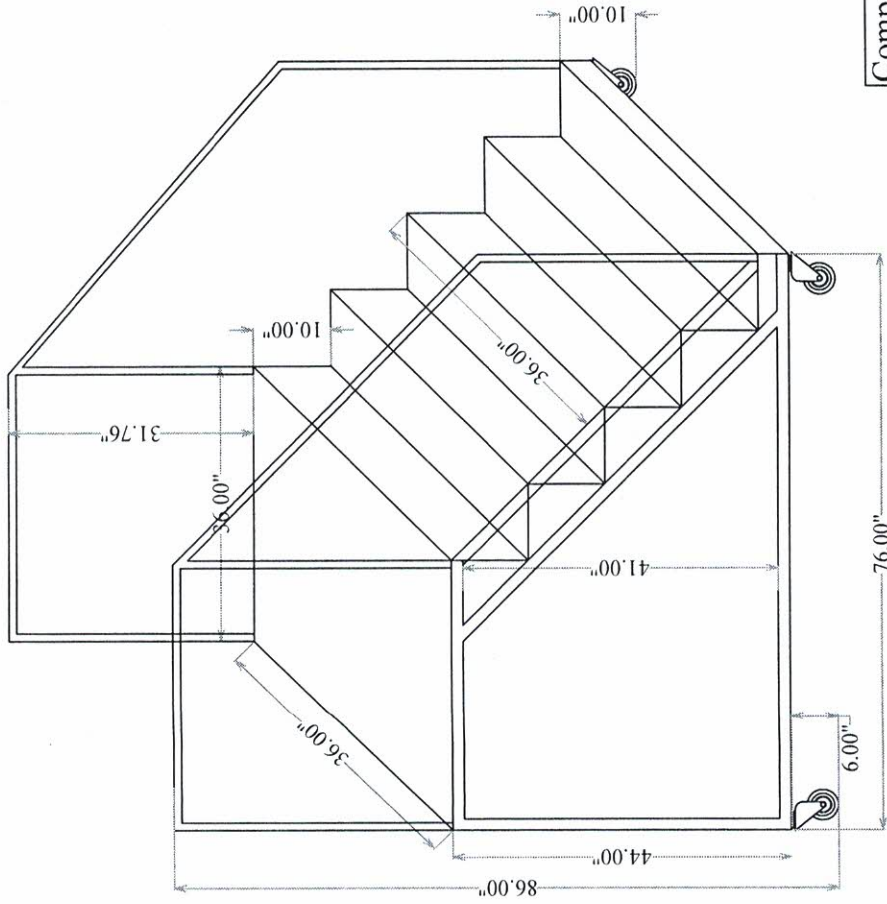

# Screw Conveyor

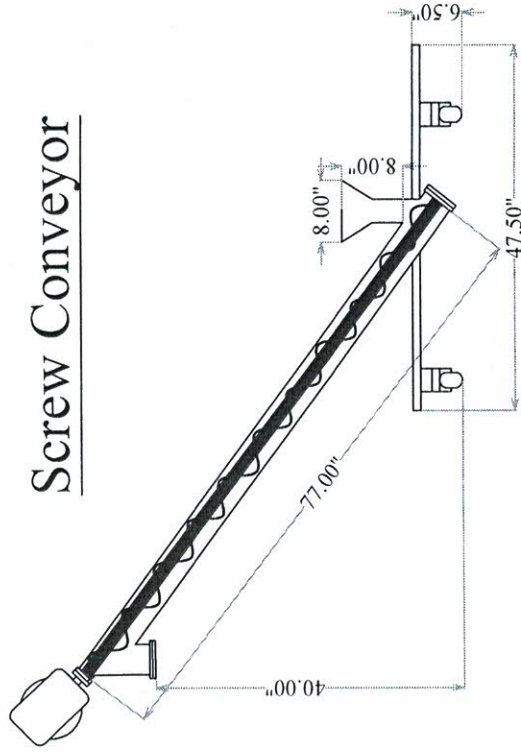

Company : Faisal Engineering
Prepared by : Younus Baig
Product : Cone Blender 1000 KG.
<b>Customer : Martin Dow Ltd</b>
All Sizes are in Inches

# Pneumatic Fittings for Vibrators

## for Vibrators

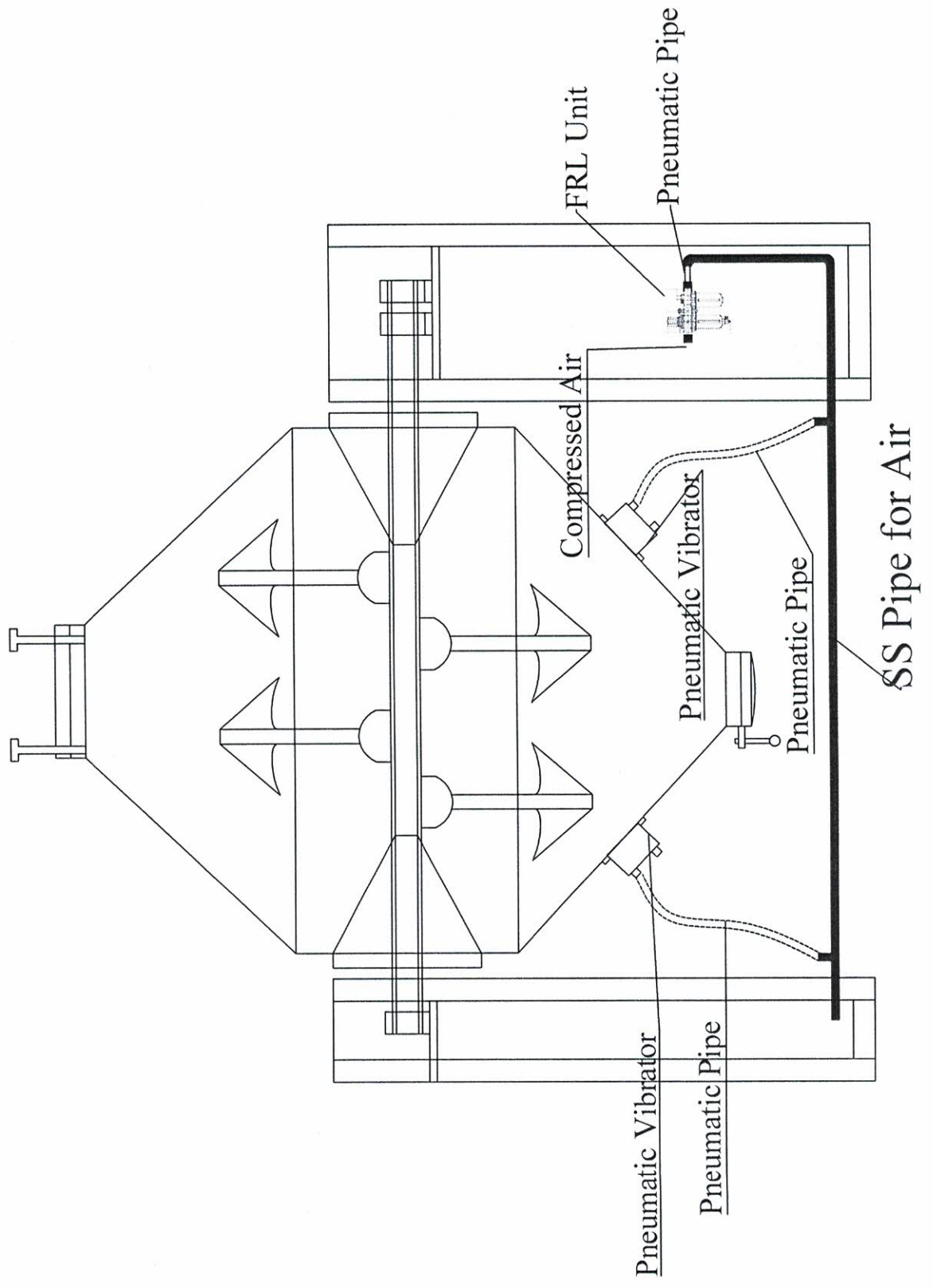

# Powder Unloading System / Screw Conveyor

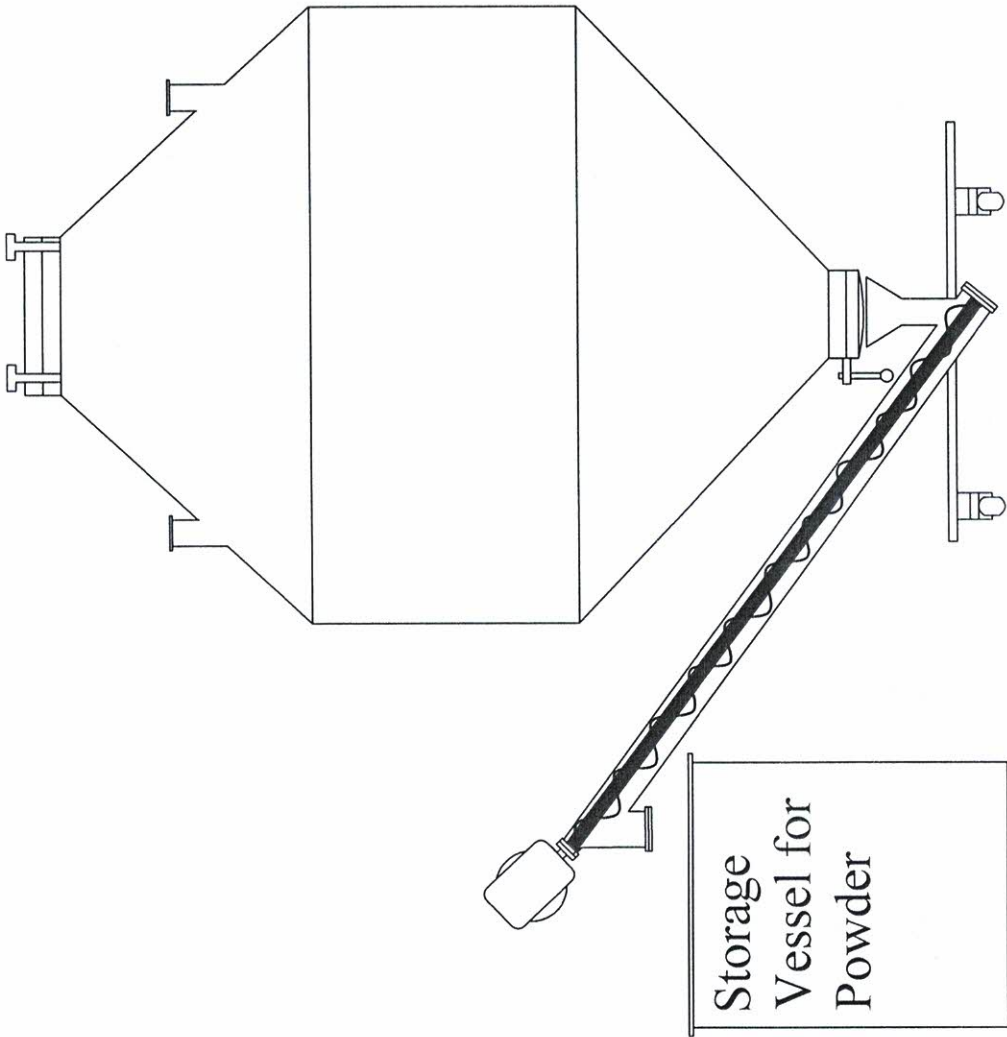

# Powder Loading System

